

Technical data sheet

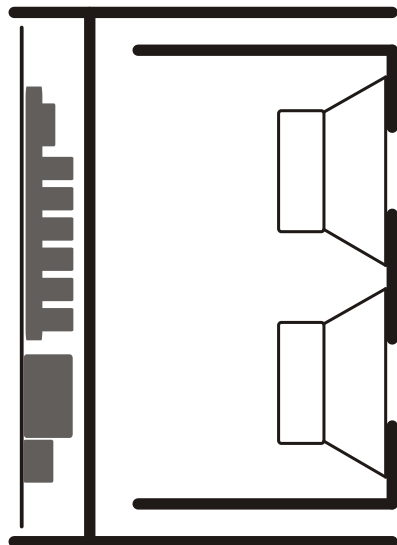

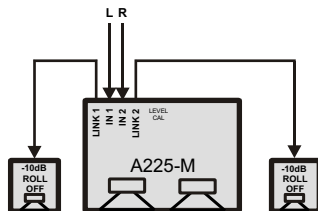

STEREO SYSTEM



5.1 SYSTEM

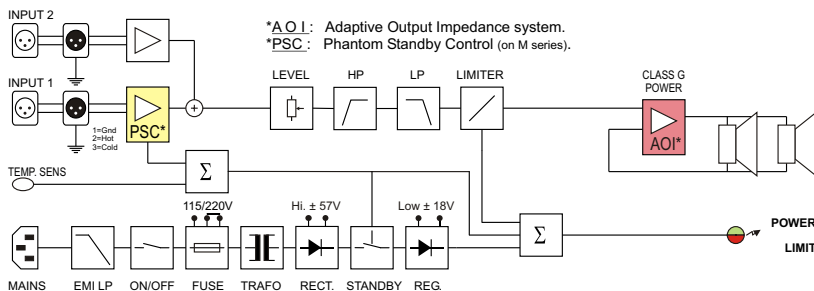
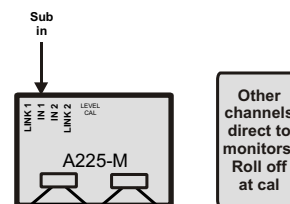

- Puissance RMS / Power RMS: **200 W**
- Puissance programme / Program power: **300 W**
- Impédance d'entrée / Input Impedance: **Sym, 10k Ohms**
- Sensibilité pour 100 dB @ 1m / Sensivity for 100 dB @ 1m: **0.775 V**
- Rapport signal sur Bruit / Signal to Noise Ratio: **-116 dBA**
- Saturation d'entrée / Input Overload: **24 Vpp**
- Niveau max. continu, 1m / Continuous Max SPL, 1m: **111 dB (single)**
- Niveau max. programme, 1m / Program Max SPL, 1m: **116dB / half space**
- Réponse à -6 dB / Response at -6dB: **24 - 100 Hz**
- Tolérances / Tolerances: **±2 dB (28Hz - 65Hz)**
- Distorsions THD / Distortion THD: **< 1.5% (50Hz-200Hz)**
- Système / System: **1 Way(s)**
- Fréquence de coupure / Crossover frequency: **90Hz**
- Dim. basses Ext. / Membrane / Woofer's dim. Ext. / Diaphragm: **2 x Ø 258 / Ø 210 mm**
- Connecteurs / Connectors: **2 x XLR F / 2 x XLR M**
- Signal entrée / Signal input: **1=GND, 2=(+), 3=(-)**
- Matériaux du boîtier / Box Material: **MDF / double box**
- Dimensions boîtier L x H x P mm / Dimensions cabinet W x H x D mm: **320 x 700 x 500**
- Poids brut / net / Gross / Net Weight: **43.1 / 38.4 Kg**
- Tension de secteur / Voltage: **115/230V (50-60Hz)**
- Consommation / Consumption Standby-Quiescent-Max: **2.5 - 7 - 240 VA**
- Humidité Moy / Max / Mean / Max Humidity: **< 75% / < 90%**
- Température externe / External Temperature: **5 - 40 °C**

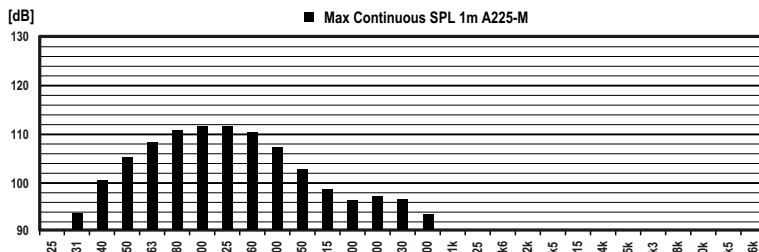
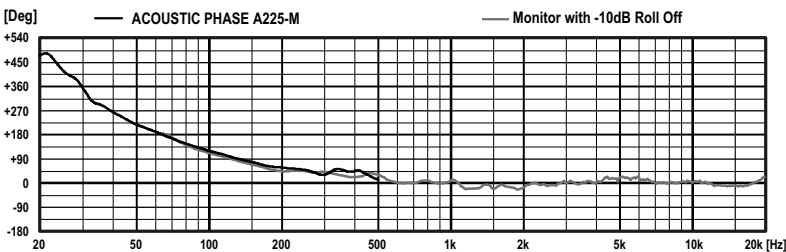
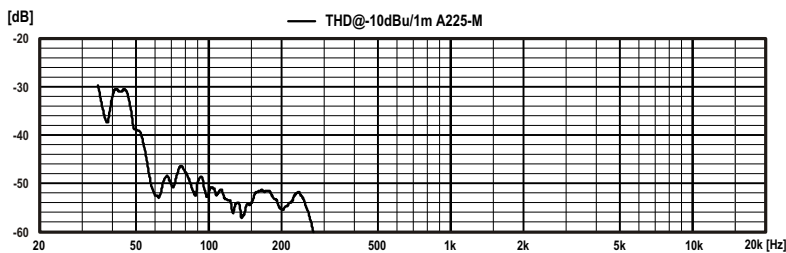
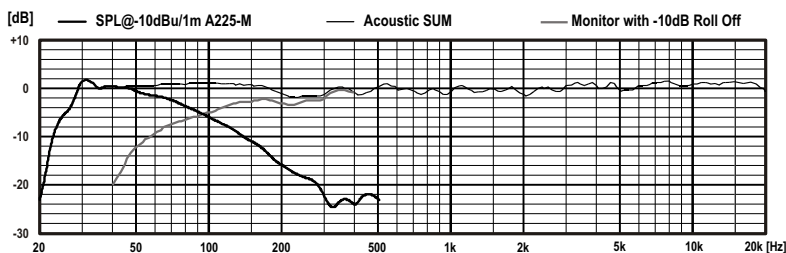

All dimensions are in mm

Mounting

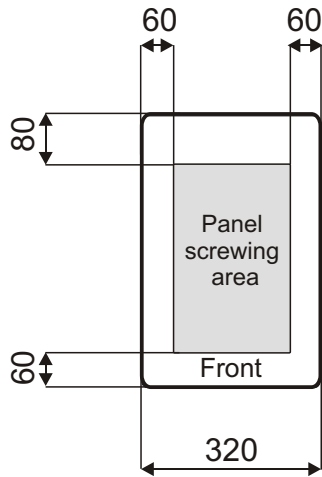

Bottom view

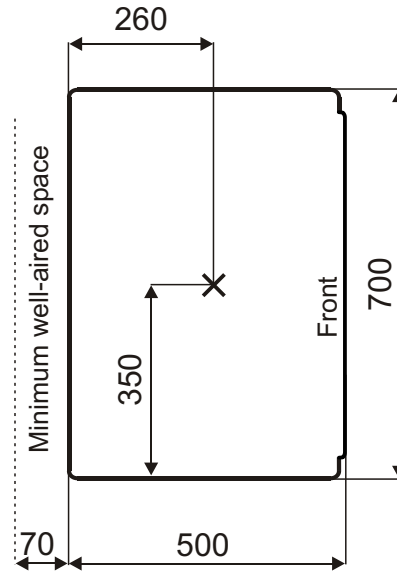

Side view

Acoustical axis

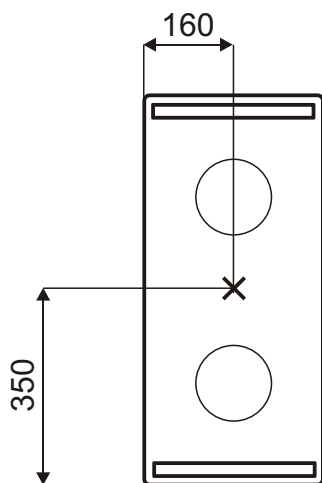

Front view

