



# Ramses **MSC**

Console Control System

## Install guide



     Direct Stream Digital

 **MERGING**  
MERGING TECHNOLOGIES

No part of this documentation may be reproduced in any form whatsoever or be stored in any data retrieval system without prior written permission of the copyright owners.

This documentation is supplied on an as-is basis. Information contained within this documentation is subject to change at any time without notice and must not be relied upon.

All company and product names are <sup>TM</sup> or Registered Trademarks © of their respective owners.

Merging Technologies makes no warranties express or implied regarding this software, its quality, performance, merchantability or fitness for a particular purpose. The software is supplied "as is" you, the purchaser, are assuming the entire risk of the results of using this Merging Technologies software.

Merging Technologies manufacturers importers or dealers shall not be liable for any incidental damages including personal injury or any other damages caused by improper use or operation of the hardware or software.

In no circumstances will Merging Technologies, its owners, directors, officers, employees or agents be liable to you for any consequential, incidental or indirect loss or damages including loss of time, loss of business, loss of profits, loss of data or similar resulting from the use of or inability to use the Merging Technologies hardware and or software or for any defect in the hardware software or documentation.

© Copyright Merging Technologies Inc. 2007. All rights reserved

## Ramses MSC Console Install Guide : Contents

Introduction	5
Scope	5
Important - Before You Begin	5
Warnings	5
Package Contents	6
Setting Up	6
Initial Connections	6
Powering Up	7
Network Setup	7
Console Mounting	11
Connection Considerations	11
Drawings	13
Figure 1: Desk Mounting Dimensions	13
Figure 2: Furniture Mounting - Screw Locations	14
Figure 3: Ramses MSC 24 Dimensions	15
Figure 4: Ramses MSC 8/16 Dimensions	17
Figure 5: Ramses MSC Back Panel	19
Figure 6: Profile Of Leather Bolster	20

# **Ramses MSC Console Installation Guide**

**For**

**Ramses Console**

**MSC 8/16/24**

***PRELIMINARY***

Document number: 01-06

Date: 13-September-2007

## Introduction

Congratulations! You have just purchased the world's most ergonomically advanced console. Your **Ramses MSC Console** should provide you with many years of trouble free operation, however it is important to carefully follow these instructions carefully when unpacking and installing the console.

## Scope

This document contains instructions for the connection and configuration of your **Ramses MSC Console**. Optional components such as the **Edit Bay** have their own, separate documentation.

**Note:** Please read this entire document before attempting to unpack or install.

If you experience any problems or need any assistance please contact your local distributor or you can contact Merging Technology technical support in Switzerland via telephone on: +41 21 946 04 44 or via email on:

[support@merging.com](mailto:support@merging.com)

## Important - Before You Begin

The **Ramses Console** weighs up to **70kg** (154 pounds) depending on the precise model. Ensure that the console is adequately supported at all times. Ensure personnel lifting the console are conversant with the appropriate mechanical handling procedures.

## Warnings

**WARNING**  
**BEFORE CONNECTING YOUR RAMSES MSC CONSOLE TO  
POWER PLEASE ENSURE THE VOLTAGE SWITCH ON THE POWER  
SUPPLY IS SET CORRECTLY!**

- Use the supplied mains power cable. Use of an incorrect mains cable is an electric shock and fire hazard
- Do not bend the power cable excessively or place heavy weights (such as this unit) onto the power cord.
- Do not use a damaged power cable. Electric shock and fire hazard
- Do not allow the console to get wet or spill any liquids on it. Fire or electric shock may result
- Do not allow any foreign objects to enter the console. Fire or electric shock may result
- The console must be earthed via the mains connection to prevent electric shock
- Only suitably qualified personnel should remove any cover to prevent electric shock
- If there is an electrical storm switch off and disconnect the console
- In the event of smoke, abnormal noise or odor switch off and unplug the console immediately.

- Do not block ventilation holes or slots. Fire hazard

## Package Contents

- Ramses MSC Console
- Mains power cable
- Five metre cross-over network cable
- Pre-installed Software (including backup disks of the Microsoft Windows XP install disk, Ramses MSC install disk, a drivers disk plus PDF User Guides)
- M6 Mounting screws for angle brackets

## Setting Up

First, position the console surface in or on top of your studio furniture. Should the console require fastening to your studio furniture then attach the console using three M6 screws on either side of the console. These screws should pass through a load bearing part of the furniture capable of supporting the full weight of the console. **Please see Console Mounting on page 11**

## Initial Connections

With the control surface securely in place cabling can commence. First, **Please see Connection Considerations on page 11**

Connect the cables at the rear beginning with the mains power:

**ENSURE MAINS POWER IS UNPLUGGED BEFORE CONTINUING**

**WARNING**  
**BEFORE CONNECTING YOUR RAMSES MSC CONSOLE TO  
POWER PLEASE ENSURE THE VOLTAGE SWITCH ON THE POWER  
SUPPLY IS SET CORRECTLY!**

The IEC mains socket is located on the right-hand side of the back of the control surface when facing the back of the unit. Connect the included mains lead between the console and an appropriate power outlet.

Next, connect the supplied cross-over network cable to the RJ45 socket on the console. The other end should be connected to your Merging MassCore PC or network switch.

If using a direct connection to the Merging MassCore PC then a cross-over cable is necessary. If the MassCore PC is part of a LAN then use a straight-through cable to connect the console to that LAN.

If the supplied network cable is of insufficient length then ensure that any replacement cable employed is a Category 5 Ethernet cable suitable for 100MB/s data speeds. It is important that the correct cabling is used to connect the console with the merging MassCore PC or network switch.

Now connect the talkback microphone output to a suitable input on your system. Phantom power is not necessary to power the microphone and does not need to be engaged on that input. Please remember to refer to the section on setting the talkback channel in the Smart Console Reference Manual.

The DB9 Serial connector on the back of your console will only need to be connected if using a third party device such as a monitoring controller system. Further instructions will be included in that case.

The USB sockets only need be connected to things such as mouse, keyboard, memory stick devices, and so forth in the case of servicing or upgrading firmware or software.

## Powering Up

The correct order for powering up the component parts of your **Ramses MSC Console** for the first time is as follows:

1. Ensure the console power supply is switched to the correct voltage for your region!
2. Plug in the mains cable and turn on the power at the wall socket. (If applicable)
3. Switch ON the power switch on the rear of the console. The switch is located on the power supply adjacent to the mains inlet.
4. Press the **Start** button.

The Active Screen will display a screen explaining that the **Ramses MSC Console** is starting up. Various lights on the console surface will shortly begin to flash. Console software will now launch, faders will move to default positions and the surface will engage with the Merging MassCore system.

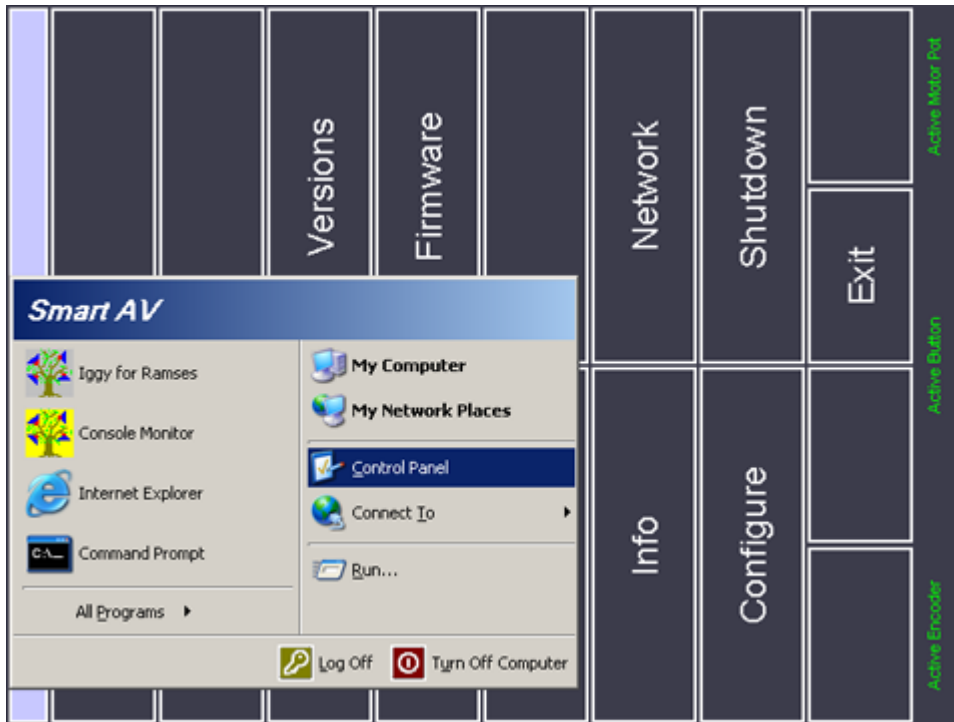
Congratulations! You are now ready to configure the Merging MassCore to operate with the Ramses MSC Console. Please refer to the **Ramses MSC Configuration Guide** for further instructions.

## Network Setup

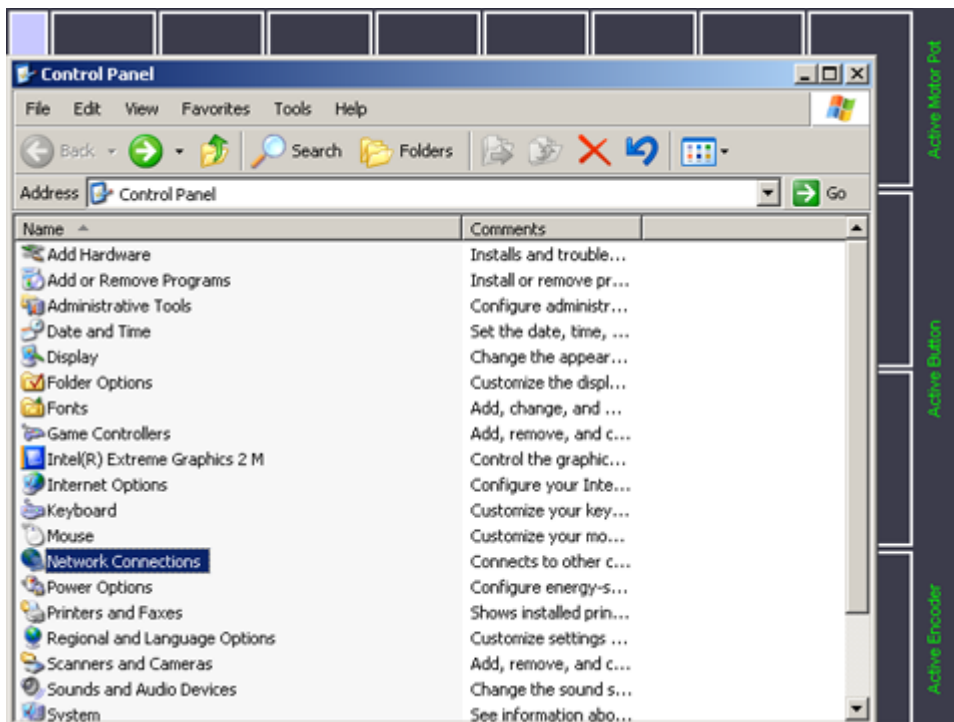
Ramses MSC communicates with Pyramix via ethernet. Your Merging Sales Partner will have set up networking parameters to suit. If you need to change Ramses MSC network settings proceed as follows:

1. First, you will need to plug in a USB mouse & keyboard.
2. Open the Windows **Start** menu by pressing the **Windows** key on the keyboard. (Windows windows will appear 'sideways' in the Active Screen. This is intentional)

3. Go to **Start Menu > Control Panel**

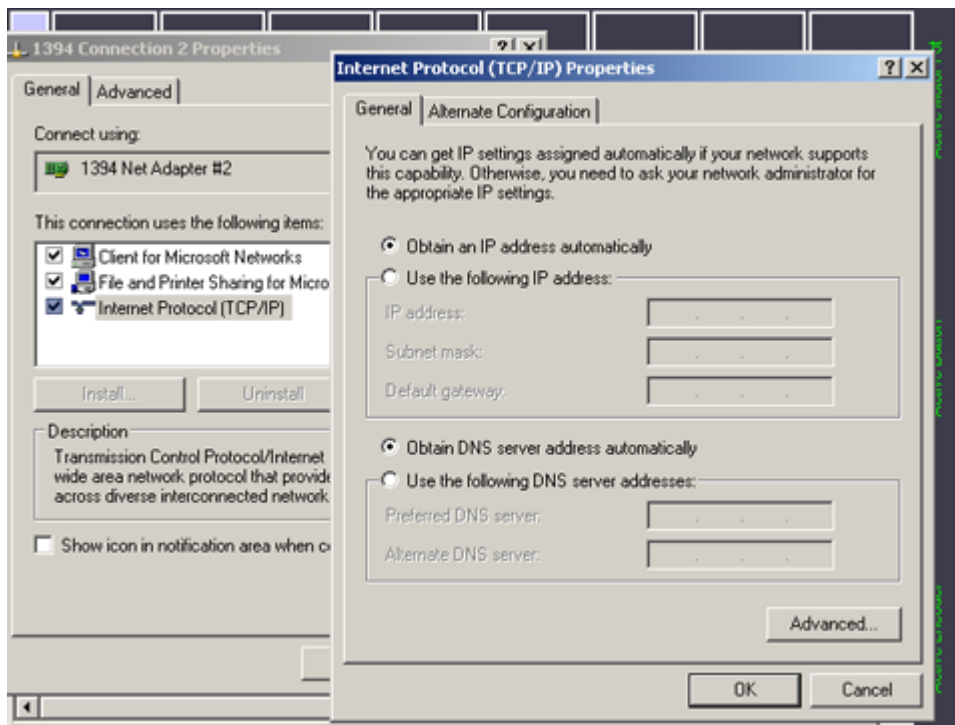


4. Go to **Network Connections** then right-click on **Local Area Connection** and select **Properties**





- Click on **Internet Protocol (TCP/IP)** to select it. (last item on the **This connection uses the following items:** list) Now click on the **Properties** button.



- If there is a DHCP server on your network select the **Obtain an IP address automatically** and **Obtain DNS server address automatically** radio buttons.
- If there is no DHCP server on your network or you need Ramses MSC to have a fixed address select the **Use following IP address:** and type appropriate IP address and subnet mask values.
- Click **OK** to close the Internet Protocol (TCP/IP) Properties window (this may take some seconds) and then click **OK** a second time in the **Local Area Connection Properties** window to close it.
- Close all open windows and return to the Ramses Iggy application using the **ALT+TAB** function. -

10. Verify in the Active Screen **System - Network** page that all is set as you wish.

System - Network			
<b>Use DHCP (active button)</b>			
<b>TRUE</b>			
<b>Console IP Address</b>			
<b>10.0.0.28</b>			
<b>Subnet Mask</b>			
<b>255.255.255.0</b>			
<b>Gateway IP Address</b>			
<b>10.0.0.1</b>			
Apply		Exit	
<small>Active Encoder</small>	<small>Active Button</small>	<small>Active Motor Pot</small>	

## Console Mounting

There are three possibilities for mounting your **Ramses MSC Console**. It can either be put on a strong, stable, flat surface or be fitted into the optional **Merging Technologies** technical furniture or be fitted into a correctly prepared unit of third-party studio furniture. Figures 1 through 5 detail the dimensions of the various **Ramses MSC Consoles**.

If the console is being installed into studio furniture please note it has been designed to be supported by three M6 screws that fit into mounting holes on each side of the console. Refer to Plate 2 for the exact location of these holes.

One method of mounting is to attach a steel angle bracket of the appropriate size via these mounting holes. This angle bracket is then mounted either to the furniture itself or to a sub-frame within the furniture so that the top surface of the furniture is flush with the top of the console surface. In this case you may use the M6 screws provided. In this case you **MUST** ensure that at least 15mm of the thread of each M6 screw is entirely within the console when fully mounted.

Alternatively the console may be attached to the furniture directly by passing screws or bolts horizontally through the furniture's frame into the console's mounting holes. In this case you must source your own screws and you **MUST** ensure that at least 15mm (and no more than 25mm) of the thread of each M6 screw is entirely within the console when fully mounted.

The console furniture should be rigid and should not rely on the console for its structural integrity. The console weighs up to 70kg (154 pounds) depending on the exact model.

If you wish to shape the front edge of your furniture to match the profile of the front bolster of the console please refer to Figure 6 for details.

**Note:** there will need to be sufficient clearance at the back of the console to allow room for rear connecting cables and ventilation. More information about rear connections is contained in the next section.

## Connection Considerations

There are several connectors on the rear of your console. Some are required and some are optional to use. Please refer to Figure 5a for Ramses MSC 8/16 and 5b for Ramses MSC 24 for the location of these connectors.

When facing the rear of the console the mains power inlet, power switch and voltage selector are located on the right-hand side. On the left-hand side is the **RJ45** cross-over Ethernet connection to the **Merging MassCore** mix engine (the left-hand socket of the two RJ45s) and the following optional connections:

- **RJ45** Ethernet port for optional **Edit Bay** (the right-hand socket of the two RJ45s)
- Talkback microphone output to MassCore system (balanced line level audio via an **XLR-3** connector)
- **USB** for upgrades as well as transfer or backup of scene and file set data
- **DB9** Serial connector (for connection to third party monitoring controllers etc.)
- **USB** for optional keyboard and mouse

Immediately to the right of this connector panel is a panel that allows the internal motherboard to slide out for servicing.

In the unlikely event of needing to service your console, you may also need to remove the larger access panel in the rear of the console immediately to the right of the motherboard panel.

These panels are perforated for cooling ventilation purposes and must not be obstructed. Please keep all of these things in mind when designing your furniture.

All the Ramses MSC Consoles require an Ethernet cable to connect them to a MassCore system. Depending on your individual set up that engine may be located in your machine room, on stage or right by your console. Generally a direct connection (using a cross-over cable) is used however some facilities may have a series of engines set up on a network (or LAN) in which case this is what your console should be connected to using a normal (non cross-over) Ethernet cable.

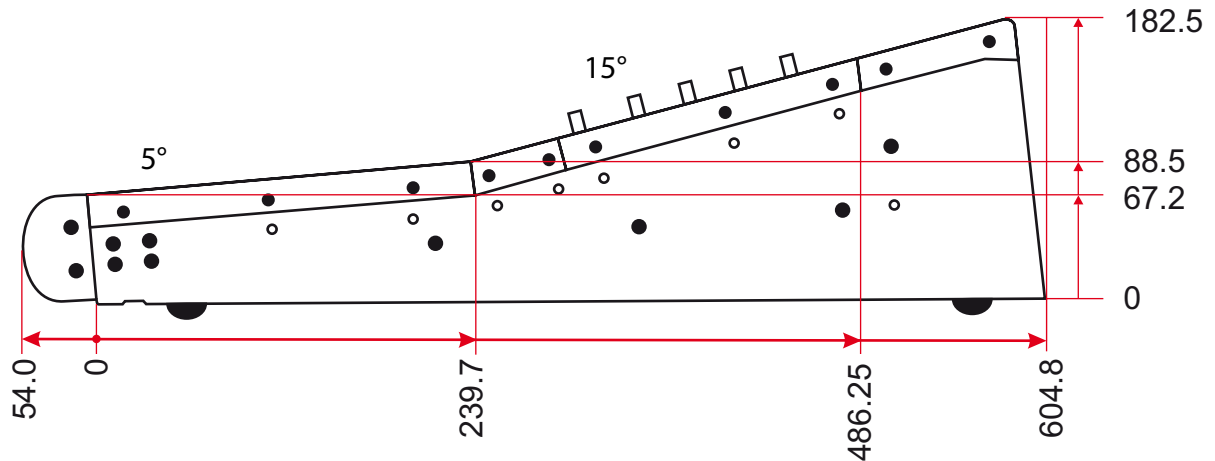
The console will require mains power. Please see the cautionary note on Page Five about setting your power supply voltage correctly!

The talkback microphone connection on the rear of the console may need to be connected to an input of the MassCore system and a cable run for this will need to be established.

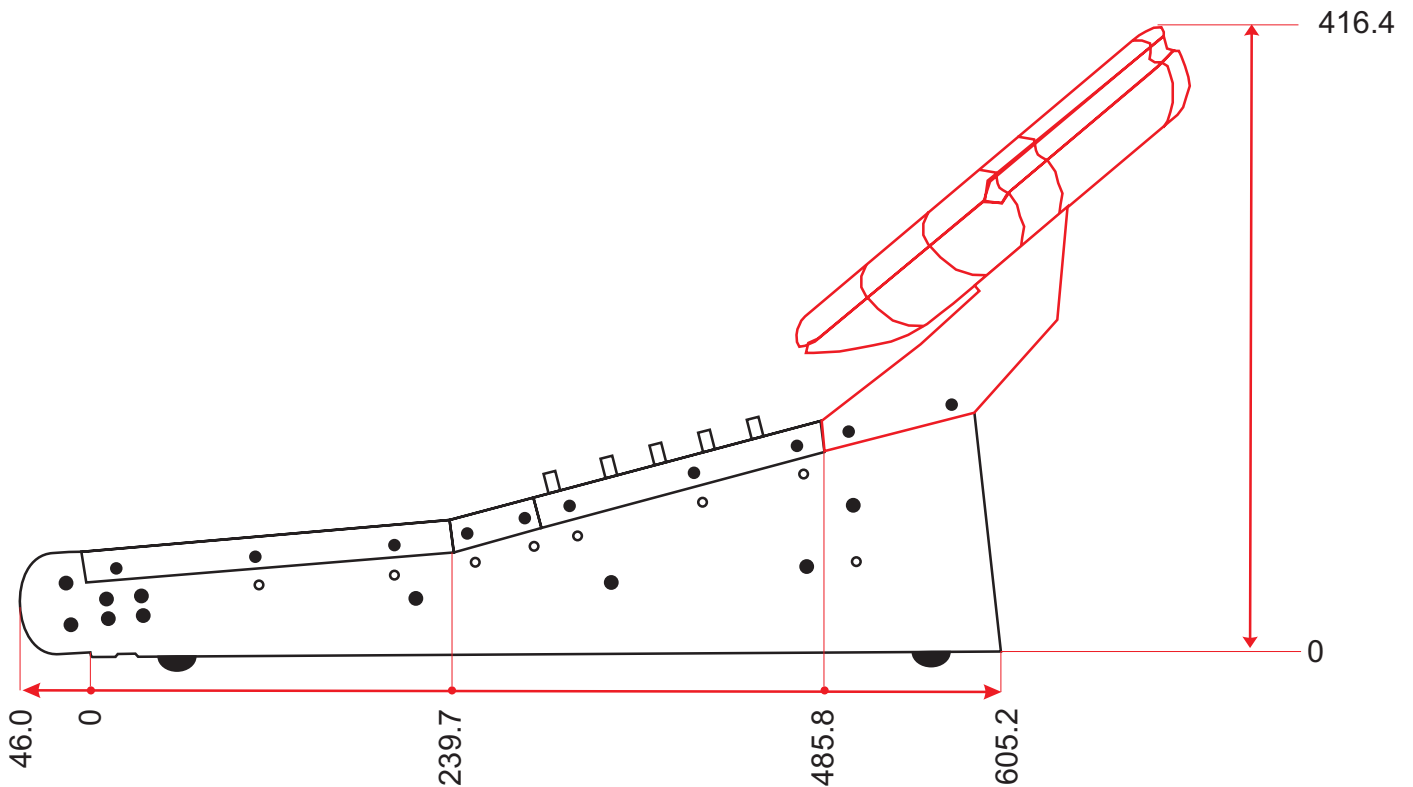
It will also be necessary to have a few helpers around for lifting, moving and positioning the control surface, as it is too large to be lifted by one person. The console weighs up to 70kg (154 pounds) depending on the exact model. Please observe all safety and lifting precautions to prevent injuries.

## Drawings

**Figure 1: Desk Mounting Dimensions**

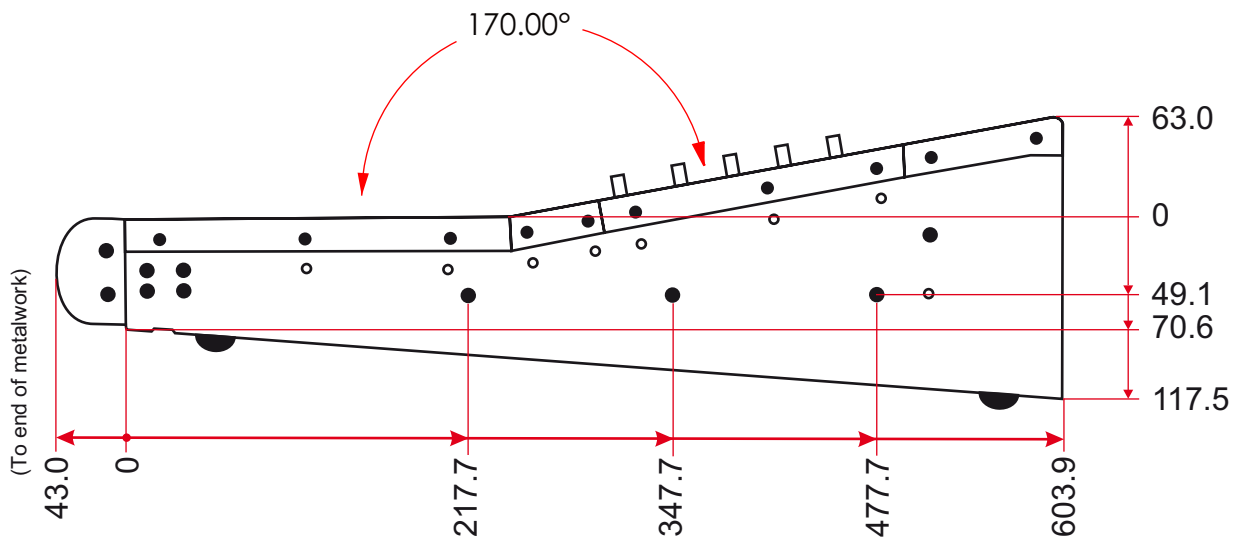


**Figure 1a:** Ramses MSC Console dimensions for desk mounting. All dimensions are in millimeters. Height of rubber feet is 5mm.

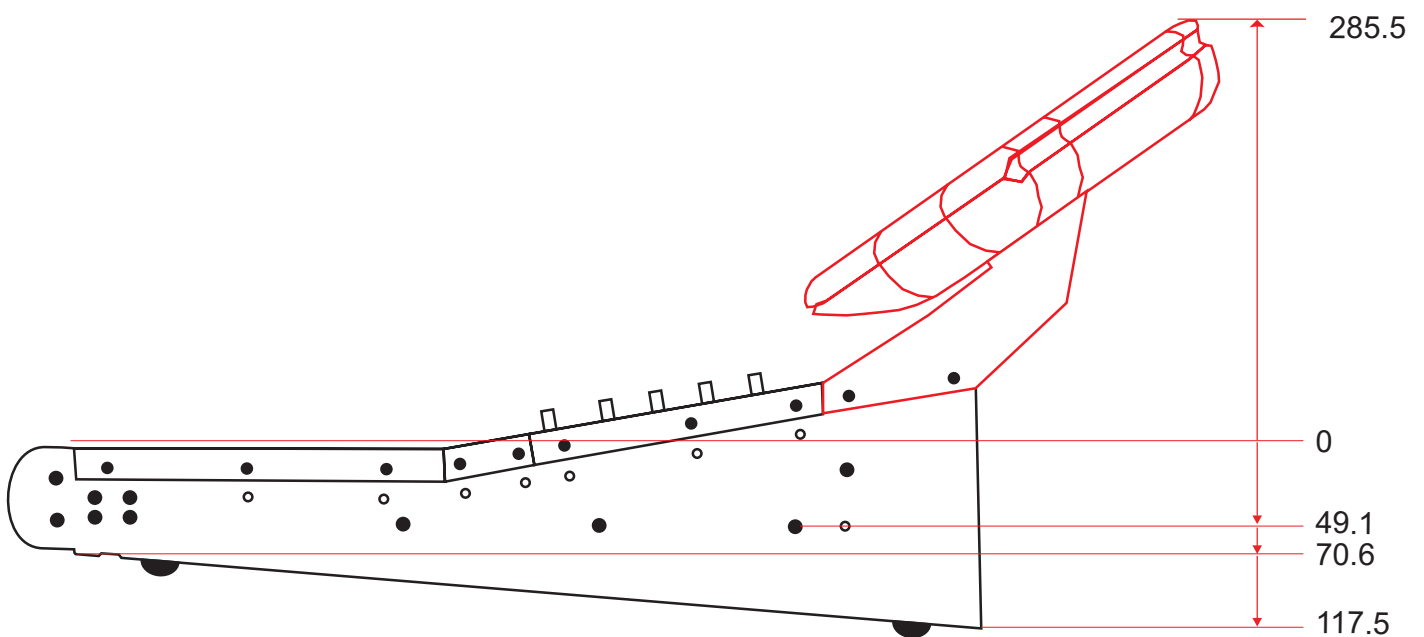


**Figure 1b:** Ramses MSC Console with ARC dimensions for desk mounting. All dimensions are in millimeters. Height of rubber feet is 5mm.

**Figure 2: Furniture Mounting - Screw Locations**

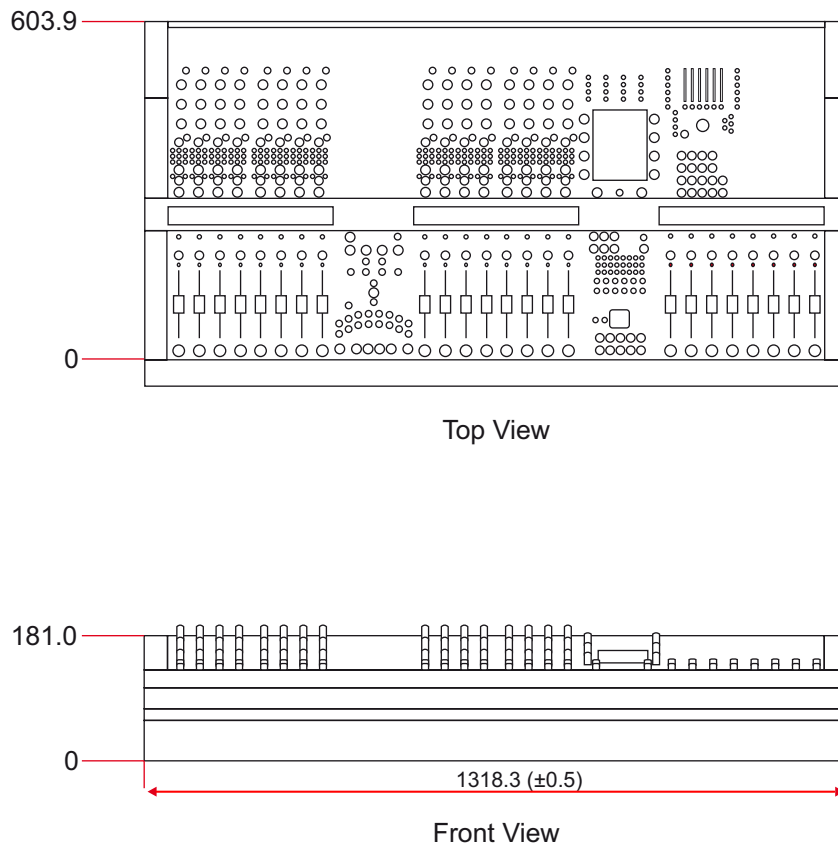


**Figure 2a:** Locations of M6 mounting screws for furniture mounting. All dimensions are in millimeters.

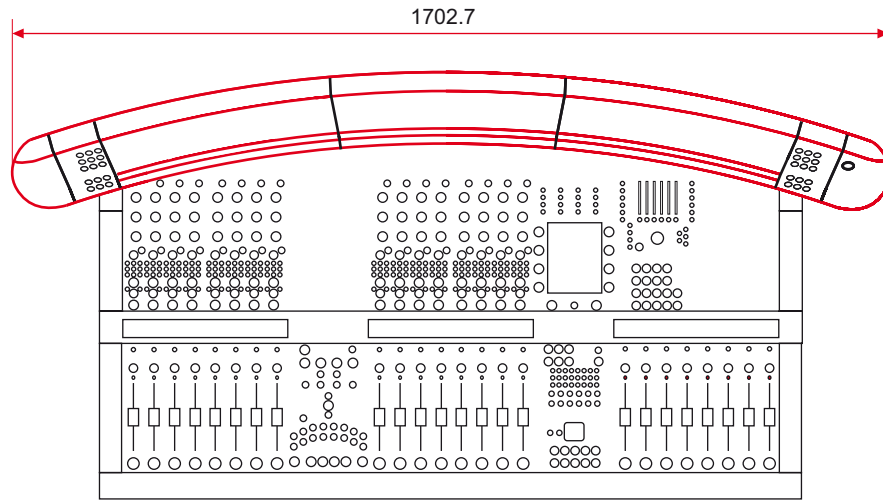


**Figure 2b:** Heights of Ramses MSC with ARC for furniture mounting. All dimensions are in millimeters.

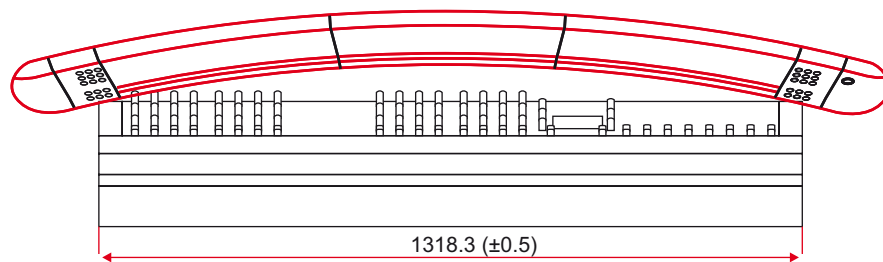
**Figure 3: Ramses MSC 24 Dimensions**



**Figure 3a:** Ramses MSC 24 dimensions. All dimensions are in millimeters.



Top View

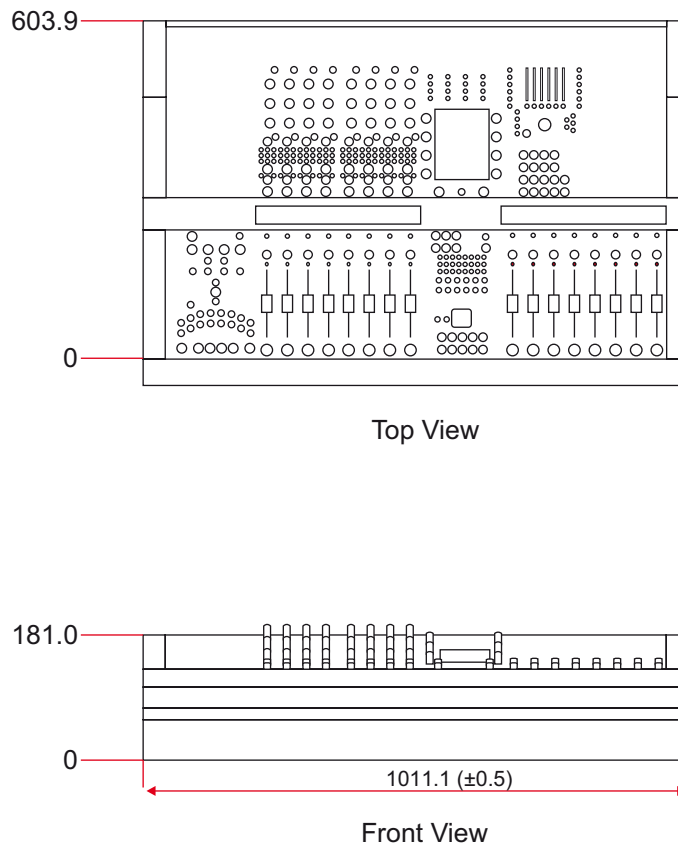


Front View

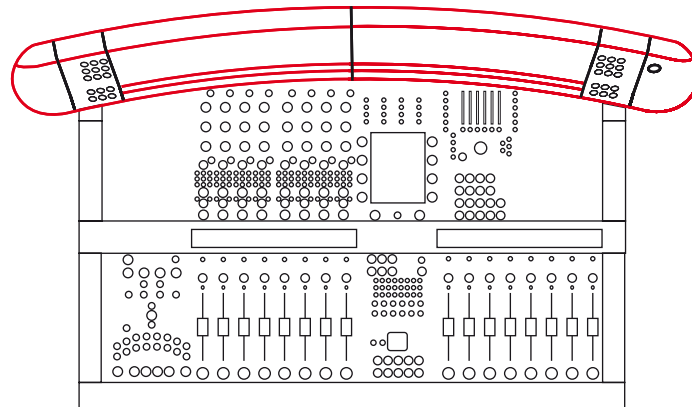
**Figure 3b:** Ramses MSC 24 with ARC dimensions. All dimensions are in millimeters.



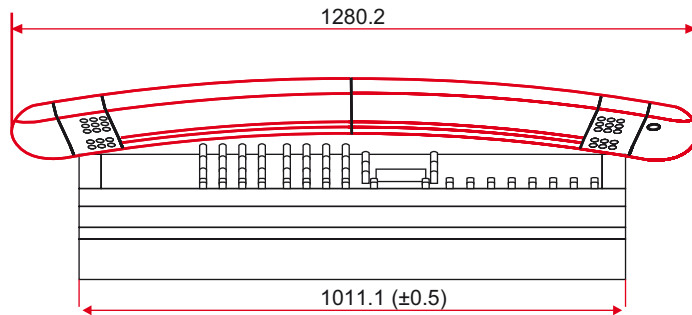
**Figure 4: Ramses MSC 8/16 Dimensions**



**Figure 4a:** Ramses MSC 8/16 dimensions. All dimensions are in millimeters.



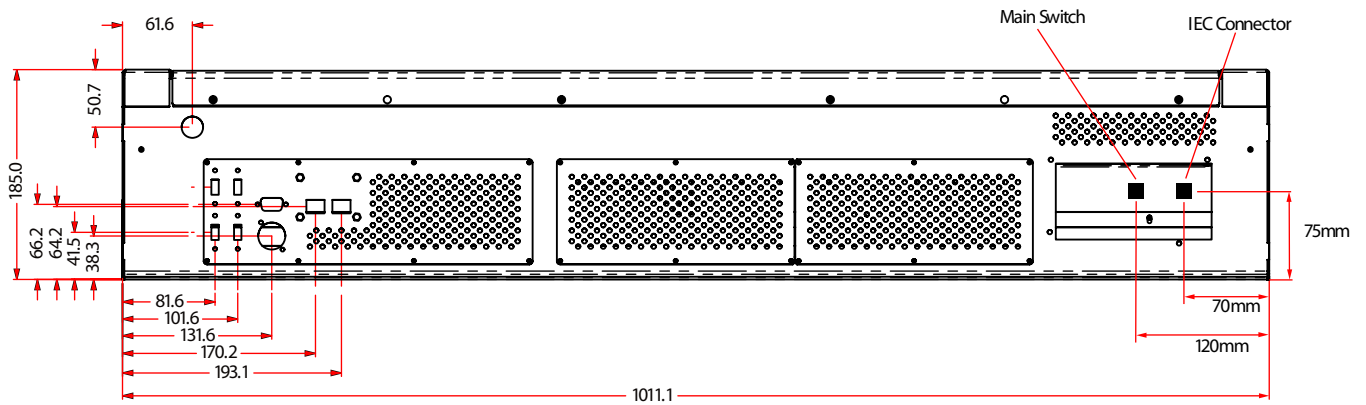
Top View



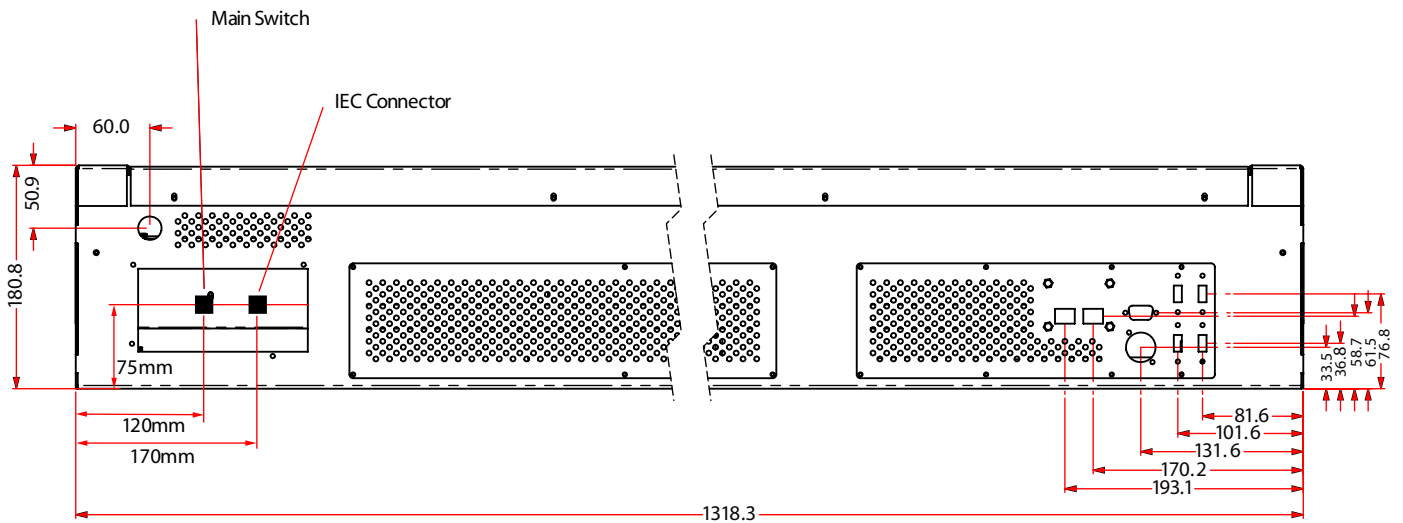
Front View

**Figure 4b:** Ramses MSC 8/16 with ARC dimensions. All dimensions are in millimeters.

**Figure 5: Ramses MSC Back Panel**

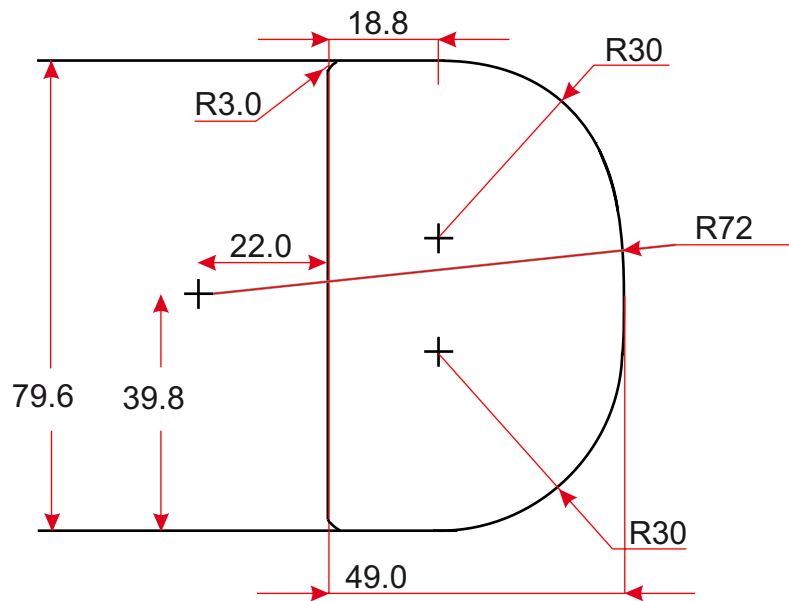


**Figure 5a:** Ramses MSC 8/16 back panel dimensions. All dimensions are in millimeters.



**Figure 5b:** Ramses MSC 24 back panel dimensions. All dimensions are in millimeters.

**Figure 6: Profile Of Leather Bolster**



**Figure 6:** Profile of leather bolster on front of console. All dimensions are in millimeters.  
**Note:** All dimensions are approximate due to the nature of upholstery.